

INSTRUCTIONS FOR INSTALLATION OF SINGLE OR DOUBLE CYLINDER DEADBOLTS AND THE REPLACEMENT OF EXISTING LOCKS

FOR USE ON DOOR THICK 1-9/16" TO 2" (40mm-51mm) TOOLS REQUIRED FOR NEW CONSTRUCTION:

1 philips head screwdriver 1 2-1/8" (54mm) hole saw 1 1" (25mm) drill & 1 chisel

TOOLS REQUIRED FOR REPLACEMENT: 1 philips head screwdriver

1. MARK DOOR

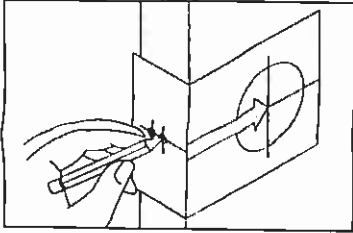

- Fold and apply template on high edge of door bevel and mark center of door edge as indicated on template at the desired height from the floor.
- Mark center hole on door face through guide on template for either 2-3/8" or 2-3/4" (60mm or 70mm) backset.

NOTE: BACKSET ON DOOR FACE MUST BE SAME AS BACKSET OF YOUR LOCK.

2. DRILL HOLES

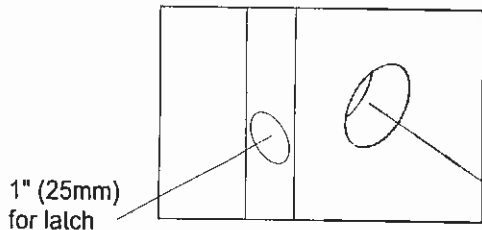

Drill holes as marked.

NOTE: DRILL 2-1/8" (54mm) HOLE FROM BOTH SIDES OF DOOR TO AVOID SPLITTING WOOD.

3. INSTALL LATCH

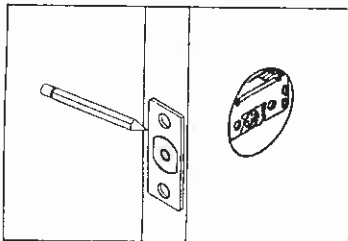

Insert latch in hole, mark outline of faceplate and remove latch.

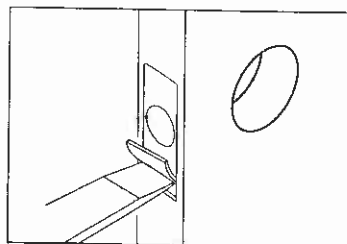

Chisel 1/8" (3mm) deep or until faceplate flush with door edge.

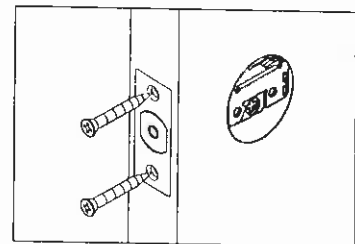

Insert latch and tighten screws.

4. INSTALL STRIKE BOX & STRIKE

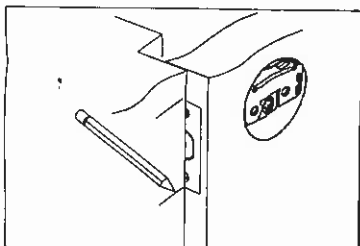

Close door to mark horizontal center line of strike.

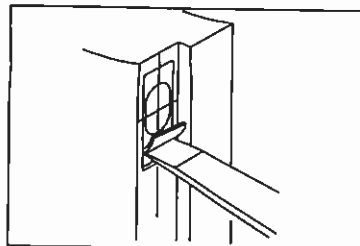

Measure one half of door thickness from door stop and vertically mark center line of strike. Drill aperture which is same with strike box 1-9/64" (29mm) deep at intersection of horizontal and vertical center line of strike. Match screw hole on strike with center lines on jamb. Mark outline and chisel 9/32" (7mm) deep for strike.

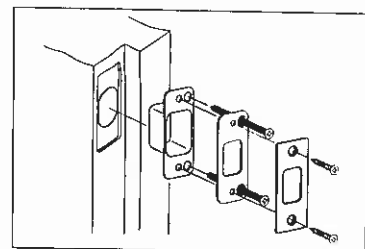

Install strike box and strike and tighten screws.

5. INSTALL SINGLE CYLINDER

INSTALL EXTERIOR MECHANISM-SINGLE CYLINDER

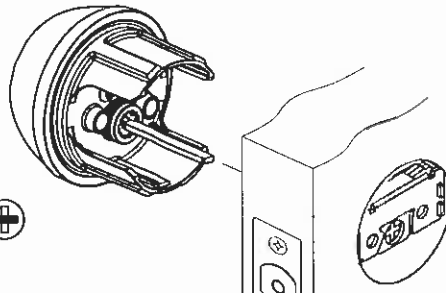
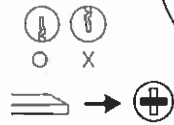

Tapped holes in housing of exterior cylinder should be lined up with screw holes. (Key hole should be in down position.)

TORQUE BLADE SHOULD BE HORIZONTALLY INSERTED INTO LATCH CRANK.

INSTALL INTERIOR MECHANISM-SINGLE CYLINDER

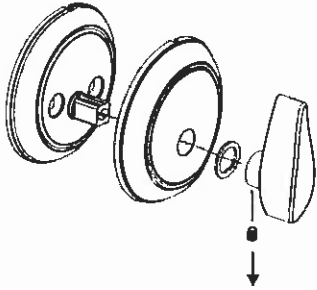

First, use wrench to get out turn piece, take out washer and separate rose and rose plate.

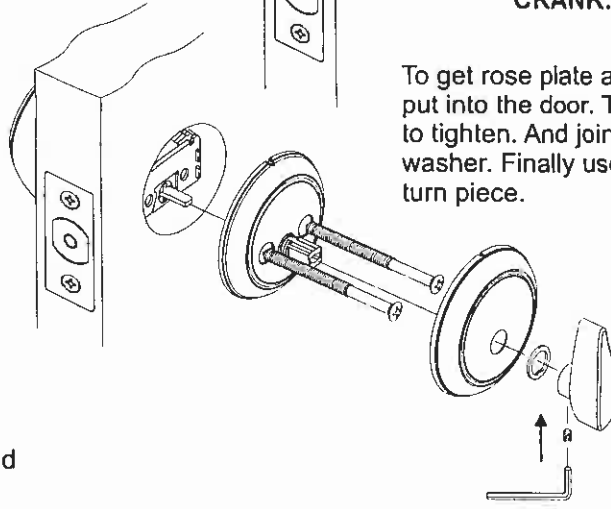

To get rose plate aim at torque blade, put into the door. Then use the screw to tighten. And join rose, put back washer. Finally use wrench to set up turn piece.

6. INSTALL DOUBLE CYLINDER

INSTALL EXTERIOR CYLINDER-DOUBLE CYLINDER

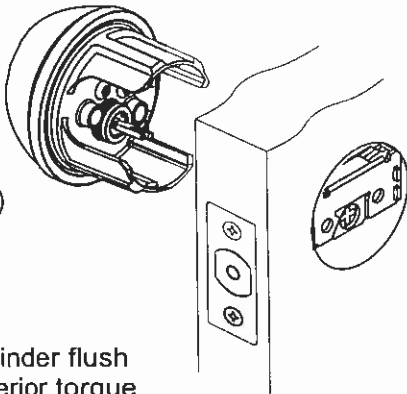
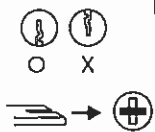

Press exterior cylinder flush against door. Exterior torque blade should be horizontally inserted into latch crank first.

INSTALL INTERIOR CYLINDER-DOUBLE CYLINDER

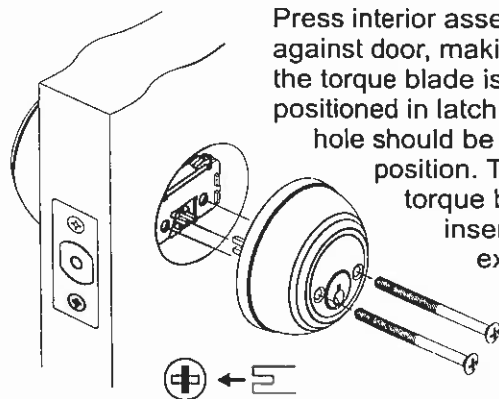

Press interior assembly flush against door, making certain the torque blade is properly positioned in latch crank. Key hole should be in down position. The interior torque blade is inserted into the exterior blade.

Insert two screws through countersunk holes engaging holes in exterior cylinder and tighten firmly.

TEMPLATE



Fold on dotted line and fit on door edge

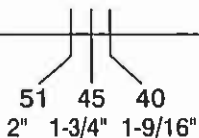

Mark 1" (25.4mm) hole at center of door edge.

FOR BACKSET
2-3/8" (60mm)

FOR BACKSET
2-3/4" (70mm)

